



Warranty Notice: ARGUS Currency Validators



Important!

On the Currency Validator, Tamper-Evident Seals have been placed at two locations (see photo above). If these seals are removed or broken, the GPT Warranty, described in this guide, will be voided.

Global Payment Technologies, Inc., (GPT) provides a Warranty to the purchaser of the **ARGUS** Currency Validator. Unless otherwise authorized, and agreed to in writing by GPT, repair of the Currency Validator is restricted to GPT-trained and authorized service personnel only. The procedures contained within this guide do not void the warranty. However, unauthorized repair, as indicated by broken Tamper-Evident Seals, will void the warranty.

ARGUS

by **GPT**



ARGUS-B



ARGUS-D

Installation and Users' Guide for ARGUS Currency Validators

Publication Number: G3M0082
(Part No. 899A0012)
Revision A—1 November 2001



Visit our web site at www.gpt.com

Important Notice

Global Payment Technologies, Inc. (the Company), reserves the right to make changes to the content of this publication, including functions and specifications identified herein, without notice.

In the absence of a written agreement to the contrary, the Company, assumes no liability for the applications assistance, customer's product/application/concepts, or infringements of patents or copyrights of third parties arising from the use of products methods and architectures described herein. Nor does the Company, warrant or represent that any license, either expressed or implied, is granted under any patent right, copyright, or other combination of technology, architecture, or software as might be or is already in use.

Note: The material contained in this document is only intended for use by the Company, its employees and any licensed or authorized user of its proprietary products and/or software.

This document has been copyrighted by the Company. The presence of any copyright notice within or upon the medium containing the Company's proprietary products shall not be construed as constituting any publication, any intention to publish or otherwise impairing the nature thereof.

© 2001 *Global Payment Technologies, Inc.*

Note: A copy of this document is available at GPT's web site: www.gpt.com/tech_sect/Default.htm

Contents

1. Introduction	4
2. Unpacking and Inspection	4
2.1 Unpacking	5
2.2 Inspection	5
3. Product Overview	5
3.1 Specifications	7
3.2 Identifying Your Currency Validator	8
3.3 Main Connector	11
3.4 Communication Protocols	12
4. Channel Reconfiguration Procedures	12
4.1 Reconfiguring ARGUS-D	12
4.2 Reconfiguring ARGUS-B	14
5. Installation Instructions	15
6. Bezel LED Displays	18
6.1 Displays for Normal Equipment Operation	18
6.2 Self-Diagnostic Error Displays	19
7. Troubleshooting	21
8. Periodic Cleaning	23
8.1 Cleaning the Bezel	23
8.2 Cleaning the Currency Channel	23
9. Testing	26
9.1 Video-Level Adjustment	26
10. Requesting Service	28
10.1 Company Directory	28

List of Figures & Tables

Figure 1. ARGUS Validator Heads	4
Figure 2. ARGUS Currency Validators	6
Figure 3. Currency Validator Label Identification	8
Figure 4. Part Number Label Numbering Scheme	8
Figure 5. Program Label Numbering Scheme – Single-Country Database ..	10
Figure 6. Program Label Numbering Scheme – Multi-Country Database	10
Figure 7. Currency Validator 22-Pin Main Connector	11
Figure 8. ARGUS-D Validator Head – Lower-Bezel Disassembly	13
Figure 9. ARGUS-B Validator Head – Lower-Bezel Disassembly	14
Figure 10. ARGUS Validator Heads	16
Figure 11. Universal SRC – Back View of Internal Parts	22
Figure 12. Currency Channel – Cleaning Surfaces	25
Figure 13. 10-Position DIP-Switch Package.....	27
Table 1. Currency Validator Troubleshooting Chart	21
Table 2. Stacker Troubleshooting Chart	22

1. INTRODUCTION

Global Payment Technologies, Inc., welcomes you to our newest generation of Currency Validators, known as **ARGUS**, the first in the **Synergy** product line. This product continues our tradition of providing the very best in currency validation. Information in this guide describes the down-stack (ARGUS-D) and back-stack (ARGUS-B) versions (see **Figure 1**) of our **Synergy** product line. Both versions of our Currency Validator are identified by the Part Number label. For sample part numbers that denote these versions, refer to **Subsection 3.2**.

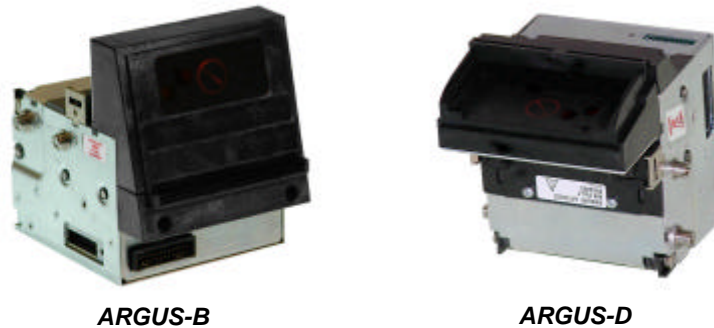

Figure 1. ARGUS Validator Heads

2. UNPACKING AND INSPECTION

The Currency Validator and Security Removable Cassette are packaged with sufficient cushioning material to protect the equipment during shipment. However, the shipping box or carton should be inspected for any signs of shipping damage (e.g., dents, breaks, water/moisture damage), or other evidence of general mishandling. If damage is found, file a complaint with the carrier, noting all damage, and notify *GPT* of such action. Also, retain the original shipping box and packaging material for inspection. Whenever possible, taking a photograph of the damaged area may prove useful in documenting the damage.

GPT ships its equipment in boxes designed to contain either a single Currency Validator or a Currency Validator with a Security Removable Cassette and an enclosure. Additionally, bulk orders can be shipped in containers, which consist of triple wall cardboard atop standard shipping skids. This method of shipping is both economical and minimizes the amount of shipping material requiring disposal.

2.1 Unpacking

To unpack the equipment, proceed as follows:

- ◆ *Cut sealing tape at top of box and open the box.*
- ◆ *Remove all parts from the box and lay them on a clean workstation.*
- ◆ *Refer to invoice, packing slip or shipment breakdown label (used on cartons only) for a complete list of parts, and verify that all parts are present.*
- ◆ *Do not discard the shipping box until after all items pass inspection.*

2.2 Inspection

After the equipment is removed from the shipping box or carton, inspect the following items:

- ◆ *External surfaces of the unit for signs of damage.*
- ◆ *Connectors for physical damage, broken or bent pins.*
- ◆ *Cables and accessories for physical damage, broken connectors, and broken or bent pins.*

If an item is damaged, report it to the carrier and to *GPT* immediately. Also, do not discard the shipping box and its packaging material.

3. PRODUCT OVERVIEW

ARGUS Currency Validators are available in two versions (i.e., ARGUS-D and ARGUS-B) that allow a Security Removable Cassette (SRC) to be mounted directly below or behind the validator (**Figure 2**). The addition of a 400-bill, Universal SRC, which provides maximum security for storing currency from 62-mm to 85-mm wide, can be used with either version. For all currency sizes, the Universal SRC is the only stacker needed for the Currency Validator.

Designed with many options, ARGUS Currency Validators are easily configured to meet the needs of different customers. For customers who wish to use their existing 70-mm SRCs for storing narrow-width currencies (i.e., up to 70-mm), the Currency Validator can be fitted with a specially-designed bezel and channel inserts. With this configuration, *GPT's* 70-mm SRC can be used instead of the Universal SRC to store narrow-width currencies.

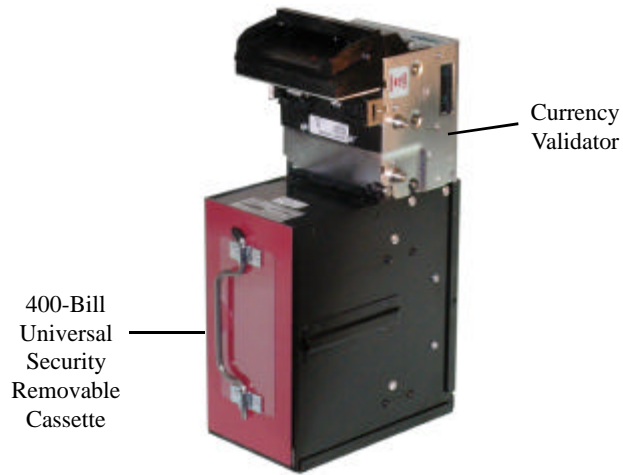

ARGUS-D Currency Validator

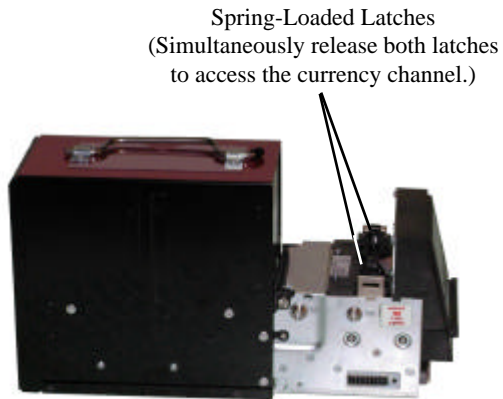

ARGUS-B Currency Validator

**Figure 2. ARGUS Currency Validators
(Shown with 400-Bill Universal SRC)**

The electrical interface between the Currency Validator and the SRC is made by a blind-mate connector (i.e., standard AMP) or by an external cable (i.e., pigtail) connector. With either option, the Currency Validator can be easily removed as needed.

3.1 Specifications

The mechanical and electrical specifications of the Currency Validator are:

- ◆ *Bank Notes Accepted*
Four direction acceptance of bank notes from 2.44 inches (62-mm) to 3.35 inches (85-mm) wide; up to 40 notes per database can be created for multi-country, multi-note configurations.
- ◆ *Optics*
Uses red, green, blue, and infrared sensors to generate 56 channels of optical information for a multi-level, high-security validation process with a 5-second cycle-time (maximum with a SRC).
- ◆ *Interface*
RS-232
- ◆ *Environment*
Operating Temperature: 0°C to 60°C
Storage Temperature: -20°C to 70°C
Humidity: 0% to 95% (non-condensing)
- ◆ *Power Source*
Standard Operating Voltage: 20 to 35 VDC
- ◆ *Power Consumption*
Idle State: 7 Watts (max.)
Accepting/Stacking States: 24 Watts (max.)
In-rush Current: 4.5 amperes (max., current limited) for 5 milliseconds at 24 VDC
- ◆ *Compliance*
ETL (UL-756)
CETL (CAN/CSA C22.2 No. 950-95)
Testable parameters comply with CE requirements.
- ◆ *Shipping Weight (Approximate)*
2.43 lbs (1.1kg) without SRC;
7.25 lbs (3.3 kg) with 400-bill SRC.

3.2 Identifying Your Currency Validator

Affixed to the back of ARGUS Currency Validator are five labels (i.e., Part Number, Program, Serial Number, Origin Country Code, and CE/Warning) that identify major characteristics of the unit (**Figure 3**).

Note: An additional **Reconfiguration** label (not shown) identifies Currency Validators that are modified in the field.



Figure 3. Currency Validator Label Identification

The **Part Number** label contains the date (i.e., month and year) that the Currency Validator was manufactured. It also contains an alphanumeric code that identifies the version number and the configurable components (i.e., mechanical and electrical) of the unit. The numbering scheme for the Part Number label is defined below (**Figure 4**):

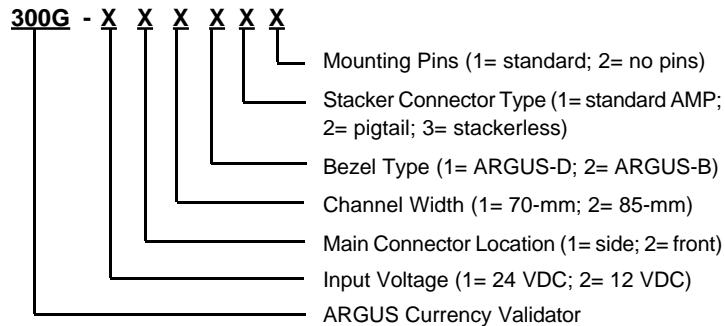

Figure 4. Part Number Label Numbering Scheme

Examples of part numbers for ARGUS-D and ARGUS-B are:

Example 1: **300G112111**

where:

- 300G** is ARGUS Currency Validator
- 1** is required input voltage (i.e., 24 VDC)
- 1** is side-mounted main connector
- 2** is 85-mm channel width
- 1** is bezel type for ARGUS-D
- 1** is standard AMP for stacker connector type
- 1** is standard mounting pins

Example 2: **300G121221**

where:

- 300G** is ARGUS Currency Validator
- 1** is required input voltage (i.e., 24 VDC)
- 2** is front-mounted main connector
- 1** is 70-mm channel width
- 2** is bezel type for ARGUS-B
- 2** is pigtail connector for stacker connector type
- 1** is standard mounting pins

The **Program** label identifies the country and contains an 8-digit alphanumeric code that defines the software characteristics of the Currency Validator. Two different numbering schemes are used to define single-country and multi-country databases. The numbering scheme for a single-country database, shown for the 8-digit number on the sample Program label, is defined as follows (**Figure 5**):

- ◆ *The first two letters represent the ISO country code*
- ◆ *The next two digits specify the database revision (up to 99, maximum)*
- ◆ *The remaining four characters specify the software revision. The first character of the software revision is a letter that identifies the software type (e.g., network or non-network), and the next three digits define the software revision number.*



Note: If a detailed description of this matrix is required, contact Customer Service (**Section 10**) for assistance.

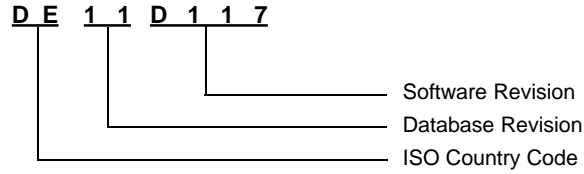

Figure 5. Program Label Numbering Scheme – Single-Country Database

The numbering scheme for multi-country databases is defined as follows (see **Figure 6**):

- ◆ The first four characters of the alphanumeric code define the database revision (i.e., one letter followed by three digits).
- ◆ The remaining four characters of the alphanumeric code identify the software type and the software revision.

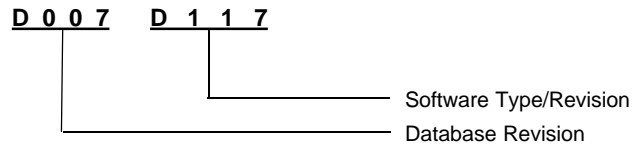

Figure 6. Program Label Numbering Scheme – Multi-Country Database

The **Serial Number** label contains a unique alphanumeric code that identifies the Currency Validator.

The **Origin Country Code** mini-label, which is usually affixed on the Serial Number Label, uses a two-letter ISO country code to indicate the country database that the Currency Validator was tested and shipped to.

The **CE/Warning** label indicates the Currency Validator complies with ETL and CETL requirements, and it also specifies the rated input power (i.e., voltage and current) that is required to safely operate the Currency Validator.

3.3 Main Connector

The Main Connector serves as the electrical interface between the Currency Validator and the host machine. This 22-pin connector supplies the power and data interface signals (**Figure 7**) to and from the Currency Validator.

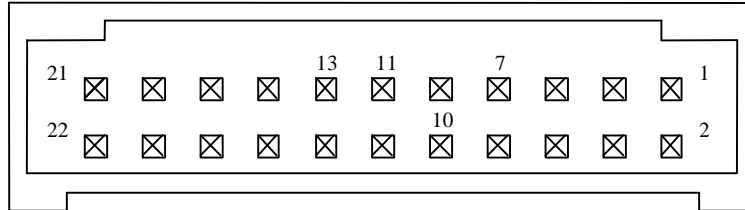

Pin 1: 24 V Sense (note 1)	Pin 12: Ground In (note 1)
Pin 2: Ground	Pin 13: Ground Out (note 1)
Pin 3: RS-232 RX	Pin 14: 15 V (reserved)
Pin 4: RS-232 TX	Pin 15: VCC (reserved)
Pin 5: Not connected (reserved)	Pin 16: SCL (reserved)
Pin 6: Not connected (reserved)	Pin 17: SDA (reserved)
Pin 7: Chassis (note 2)	Pin 18: Not connected (reserved)
Pin 8: Ground	Pin 19: Not connected (reserved)
Pin 9: Account Number	Pin 20: Ground
Pin 10: 24 V In (note 1)	Pin 21: Ground
Pin 11: 24 V Out (note 1)	Pin 22: Ground Sense (note 1)

Figure 7. Currency Validator 22-Pin Main Connector

Notes to Figure 7:

☞

1. Cable design should connect power to pins 10 and 12 on the Currency Validator. The cable should connect 24 V Sense (Pin 1) to 24 V Out (Pin 11) and Ground Sense (Pin 22) to Ground Out (Pin 13). The Currency Validator will not power up if 24 V Sense and Ground Sense are not connected as required.

2. Pin 7 is connected directly to the chassis of the Currency Validator. The chassis is connected to Ground signals internally to the Currency Validator through a 0.1-ohm resistance.

A separate, remotely located power supply, which can generate 24 VDC, is required to operate the Currency Validator. An acceptable input voltage range is from 20 to 35 VDC.

3.4 Communication Protocols

The ARGUS Currency Validator supports serial RS-232 communications which is the interface used with either the standard or enhanced version of the V2.2 protocol supplied by *GPT*. This protocol is compatible with host machines using the V2.2 protocol. For information about using the Currency Validator with other protocols, contact *GPT* Customer Service (**Section 10**).

When the Currency Validator requires service, changes to the operational setup can be made via the 10-position DIP-Switch package. To obtain the functions of each switch, refer to the Program Specification Sheet for your software application.



Note: If the Program Specification Sheet is unavailable, contact *GPT* Customer Service for assistance.

4. CHANNEL RECONFIGURATION PROCEDURES

Information in this section describes how to change the width of the currency channel to accommodate 70-mm or 85-mm wide currency. When using the 70-mm SRC, the width of the currency channel must be reduced from 85-mm to 70-mm to prevent bill jams.

To modify the currency channel for the 70-mm width, the technician will install two channel inserts and change the Lower-Bezel. Conversely, to modify the currency channel for the 85-mm width, the technician will remove the channel inserts and change the Lower-Bezel.

4.1 Reconfiguring ARGUS-D

To reconfigure the ARGUS-D currency channel, obtain the following items:

- ◆ #1 *Phillips-head screwdriver*
 - ◆ *Accessory Bezel Kit for ARGUS-D Currency Validator; items required for 70-mm channel width only:*
 - Left-Side Channel Insert (*GPT* PN 300C0244-1)
 - Right-Side Channel Insert (*GPT* PN 300C0244-2)
 - 70-mm Lower-Bezel (*GPT* PN 300D0164), or
 - ◆ *Items required for 85-mm channel width:*
 - 85-mm Lower-Bezel (*GPT* PN 300D0163).
1. Open the Currency Validator by simultaneously releasing the spring-loaded latches and swinging out the Upper-Guide Assembly, exposing the currency channel with its optical system and magnetic head (**Figure 8**).

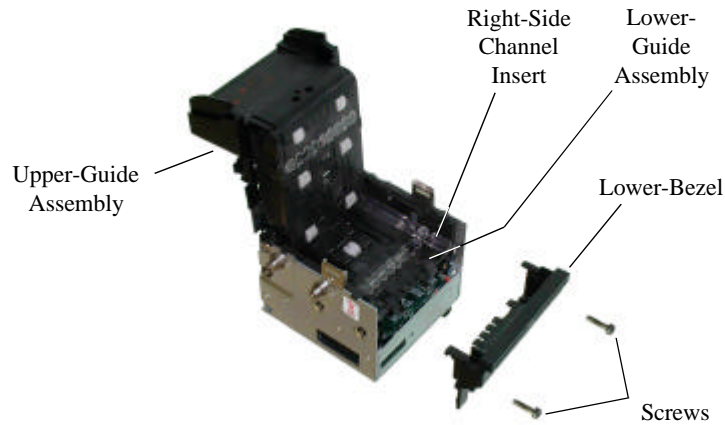

Figure 8. ARGUS-D Validator Head – Lower-Bezel Disassembly

2. Remove and retain two screws that secure the Lower-Bezel to validator head; remove the Lower-Bezel by lifting it to disengage the tabs from the Lower-Guide Assembly.

℘

Note: To reduce the width of the currency channel to 70-mm, perform step 3. To increase the width of the currency channel to 85-mm, proceed to step 4.

3. Install the Right-Side Channel Insert onto the Lower-Guide Assembly by sliding it into position; ensure locking tabs are fully engaged in openings of Lower-Guide Assembly; repeat this step for Left-Side Channel Insert, and proceed to step 5.
4. Remove the Right-Side Channel Insert from the Lower-Guide Assembly by sliding it forward and lifting it away from the Lower-Guide Assembly; repeat this step for Left-Side Channel Insert.
5. Install the new Lower-Bezel to the Lower-Guide Assembly as follows:
 - a) Place fingers (six, total), at bottom of Lower-Bezel, into recesses of Lower-Guide Assembly.
 - b) Engage two tabs, at top of Lower-Bezel, against Lower-Guide Assembly.
 - c) Secure Lower-Bezel into place with two screws.
6. Swing the Upper-Guide Assembly to its fully closed (locked) position, and verify that the spring-loaded latches are engaged.
7. Attach the Reconfiguration label to the back of the unit.
8. Perform the Video-Level Adjustment (**Subsection 9.1**).

4.2 Reconfiguring ARGUS-B

To reconfigure the ARGUS-B currency channel, obtain the following items:

- ◆ #1 Phillips-head screwdriver
- ◆ *Accessory Bezel Kit for ARGUS-B Currency Validator; items required for 70-mm channel width only:*
 - Left-Side Channel Insert (GPT PN 300C0244-1)
 - Right-Side Channel Insert (GPT PN 300C0244-2)
 - 70-mm Lower-Bezel (GPT PN 300D0306), or

Items required for 85-mm channel width:

85-mm Lower-Bezel (GPT PN 300D0302-2)

1. Open the Currency Validator by releasing the spring-loaded latches and swinging out the Upper-Guide Assembly, exposing the currency channel with its optical system and magnetic head (**Figure 9**).

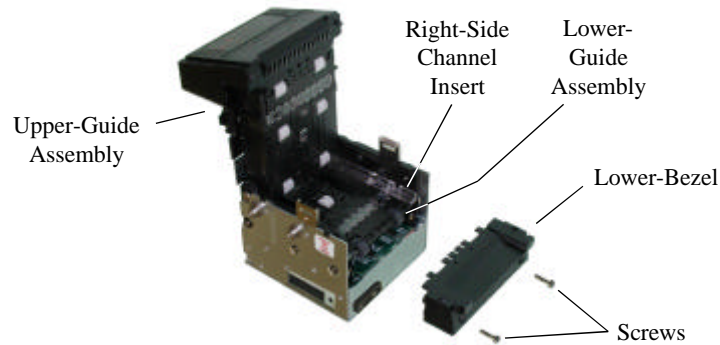

Figure 9. ARGUS-B Validator Head – Lower-Bezel Disassembly

2. Remove and retain two screws that secure the Lower-Bezel to validator head, and remove the Lower-Bezel.

GR

Note: To reduce the width of the currency channel to 70-mm, perform step 3. To increase the width of the currency channel to 85-mm, proceed to step 4.

3. Install the Right-Side Channel Insert onto the Lower-Guide Assembly by sliding it into position; ensure locking tabs are fully engaged in openings of Lower-Guide Assembly; repeat this step for Left-Side Channel Insert, and proceed to step 5.

4. Remove the Right-Side Channel Insert from the Lower-Guide Assembly by sliding it forward and lifting it away from the Lower-Guide Assembly; repeat this step for Left-Side Channel Insert.
5. Install the new Lower-Bezel to the Lower-Guide Assembly as follows:
 - a) Place fingers (six), at bottom of Lower-Bezel, into recesses of Lower-Guide Assembly.
 - b) Secure Lower-Bezel into place with two screws.
6. Swing the Upper-Guide Assembly to its fully closed (locked) position, and verify that the spring-loaded latches are engaged.
7. Attach the Reconfiguration label to the back of the unit.
8. Perform the Video-Level Adjustment (**Subsection 9.1**).

5. INSTALLATION INSTRUCTIONS

Information in this section describes how to install the ARGUS Currency Validator (**Figure 10**) into a host machine. To obtain dimensional drawings of the ARGUS-D and ARGUS-B validator heads and stackers, contact Customer Service (**Section 10**).



WARNING: AVOID PERSONAL INJURY AND/OR DAMAGE TO EQUIPMENT. DISCONNECT POWER BEFORE SERVICING THE HOST MACHINE.

5.1 Installation Procedure

To install the Currency Validator, proceed as follows:

1. Disconnect electrical power to the host machine.
2. Ensure all DIP-switches are set according to the data in the Program Specification Sheet or the Interface Box Specification Sheet.
3. Using the appropriate hardware, secure the enclosure (if applicable) to the host machine.
4. Mount the Currency Validator into the enclosure of the host machine; ensure all four alignment pins of the Currency Validator are evenly engaged within the slots of the enclosure.



Note: The **CAUTION** label (shown below), which is affixed to the Currency Validator, specifies that the latches should be fully engaged prior to installation.



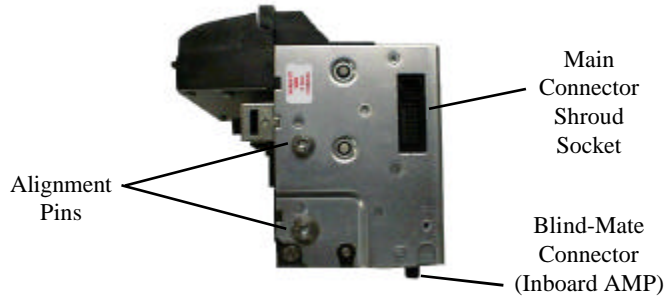

**ARGUS-D Validator Head
(Shown with Side-Mounted Main Connector)**

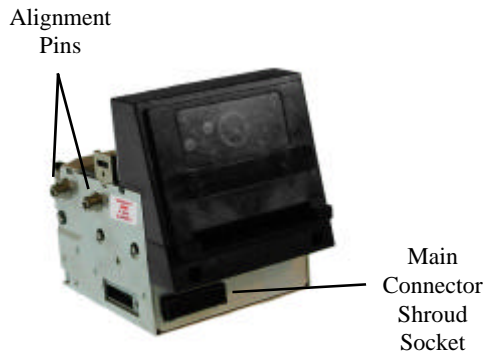

**ARGUS-B Validator Head
(Shown with Front-Mounted Main Connector)**

Figure 10. ARGUS Validator Heads



WARNING: PERSONAL INJURY AND/OR DAMAGE TO EQUIPMENT MAY RESULT BY APPLYING INCORRECT VOLTAGE TO THE CURRENCY VALIDATOR. ONLY APPLY VOLTAGE AS SPECIFIED ON **WARNING** LABEL (**Figure 3**).

5. Connect the Main Connector Cable to the 22-pin, Main Connector Shroud Socket on the Currency Validator.
6. Connect the appropriate interface-harness cable from the host machine to the Currency Validator's Main Connector Cable.
7. Carefully place all cables to avoid interference with equipment operation.
8. Mount the Security Removable Cassette into the enclosure and engage it to the blind-mate connector (i.e., inboard AMP configuration) on the Currency Validator; if the pigtail connector is used, connect it to the stacker.



WARNING: PERSONAL INJURY AND/OR DAMAGE TO EQUIPMENT MAY RESULT BY APPLYING INCORRECT VOLTAGE TO THE HOST MACHINE.

9. Apply electrical power to the host machine.
10. Close the door of the host machine.



Note: On the bezel, observe that each pair of green LEDs are flashing sequentially at 4 Hertz. If LEDs are not flashing, or the red LED is lit, proceed to Troubleshooting (**Section 7**).

11. The Currency Validator is operational and ready to accept currency.

6. BEZEL LED DISPLAYS

The bezel of the Currency Validator communicates diagnostic information and host machine status to service personnel through lighted LED display patterns. The sample bezel displays in this section represent programmed patterns for the V2.2 protocol.

Various display patterns indicate the stages of the bill verification process and denote when an equipment malfunction has occurred. On power-up, the Currency Validator performs a self-test routine. If the unit is operational, the bezel will show a runway light pattern (i.e., Idle State). However, if a malfunction is detected, a self-diagnostic error display will occur as described in **Subsection 6.2**.

 **Note:** Performance data, detailed and historical, is available through RS-232 communication and/or the Soft Drop Analyzer. For details of the software diagnostics package available from *GPT*, contact Customer Service (**Section 10**).

6.1 Displays for Normal Equipment Operation

As the bill moves through the currency channel, light patterns are displayed on the bezel that identify the current state of the unit. Shown below are the light patterns and their associated Currency Validator states for normal equipment operation.

 **Note:** The lit, green LEDs are represented by the solid, triangular-shaped symbols.

- ◆ *Idle State*
The Currency Validator is operational and ready to accept a bill.

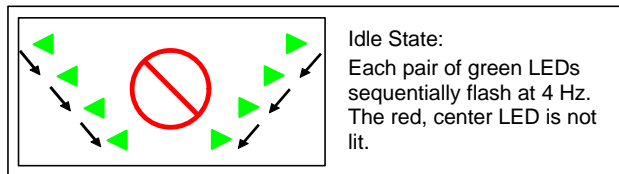

◆ *Accepting State*

A bill is inserted into the Currency Validator. The front sensor is activated, and the unit is accepting data and evaluating the bill to determine if it is valid.

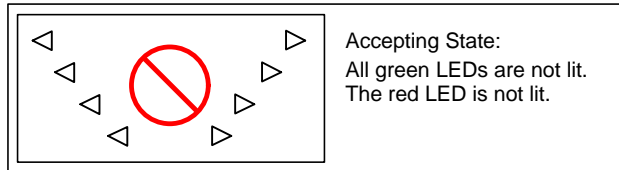

◆ *Escrow State, Stacking State, and Rejecting State*

When the Currency Validator enters the Escrow State, the Stacking State, or the Rejecting State, the light pattern shown below is displayed.

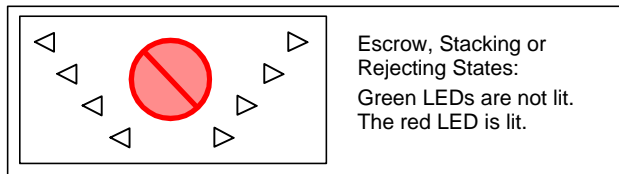

Note: If an equipment malfunction occurs, the Currency Validator will not accept the bill (**Subsection 6.2**).

6.2 Self-Diagnostic Error Displays

Besides the light patterns shown in **Subsection 6.1**, the Currency Validator provides self-diagnostic error displays when an equipment malfunction occurs. The most common types of errors appear below. For corrective actions, refer to Troubleshooting (**Section 7**).

◆ Any one of the following conditions can cause this display:

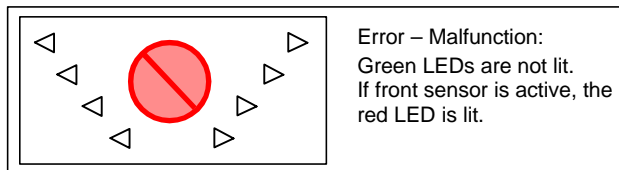

Global Payment Technologies, Inc.

(1) A bill is inserted in the channel but does not advance into the channel.

(2) Stacker is not connected to the Currency Validator and Stacker Required Mode is enabled.

(3) The Currency Validator is operational but has been inhibited (i.e., Inhibited State) from accepting bills. This condition can be caused by an inhibit command issued by the controller or a communication failure between the equipment.

- ◆ Bill jams in the channel – middle sensor is covered.

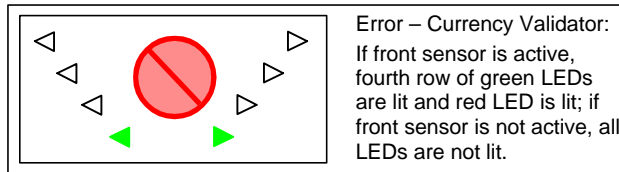

- ◆ Stacker is jammed or full.

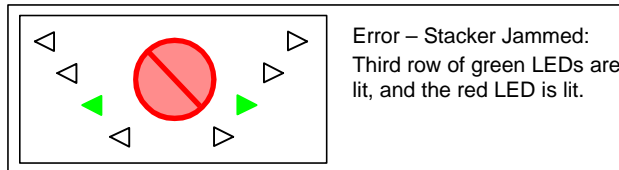

7. TROUBLESHOOTING

The possible causes and corrective actions for malfunctions associated with Currency Validator (**Table 1**) and stacker (**Table 2**) appear in this section. If corrective action fails to resolve the problem, contact Customer Service (**Section 10**). Should the unit require cleaning, refer to Periodic Cleaning (**Section 8**).



Note: Repair of the Currency Validator is restricted to the corrective actions stated in **Table 1**. Unauthorized repair, as indicated by broken Tamper-Evident Seals, will void the warranty.

Table 1. Currency Validator Troubleshooting Chart

Symptom	Possible Causes	Corrective Actions
Currency Validator is not working; bezel LEDs are not lit.	External power (+24 VDC or GND) is not applied to the Currency Validator.	Verify that +24 VDC and ground are connected to the appropriate pins on the Main Connector (Figure 7).
	Damaged connector and/or pins on the Main Connector.	Check for bent, missing or damaged pins on the Main Connector.
At power up, stepper motor turns 5 times and then stops.	Front and/or rear optical sensors are blocked, dirty, or damaged.	Clean front and rear optical sensors, and check that sensors are not blocked or physically damaged. Perform VLA (Section 9).
Bills continually jam in the channel.	Drive belt(s) and/or pressure rollers are dirty, damaged or loose.	Clean the exposed drive belts and pressure rollers; check drive belt(s) for damage and for proper tension.
	Foreign object(s) is in the channel.	Remove foreign objects from the channel; ensure channel is free of all debris.

Table 2. Stacker Troubleshooting Chart

Symptom	Possible Causes	Corrective Actions
Stacker malfunctions.	Stacker entry slot is blocked by the Pusher Plate (Figure 11).	Check the Stacker's entry slot for possible damage and/or blockage. Also, check slide guide for damage.
	Foreign object jamming drive gears.	Remove foreign object from drive gears.
	Stacker may be full.	Empty the Stacker.
Bills jam in Stacker.	Dirty bill guides or foreign objects in the Stacker.	Clean bill guides; remove foreign objects.
	Stacker may be full.	Empty the Stacker.
Currency Validator reports a Stacker jam but bill is not jammed in Stacker.	Pusher Plate Sensor is damaged and does not allow Pusher Plate to return to the top-most position.	Replace the Stacker.

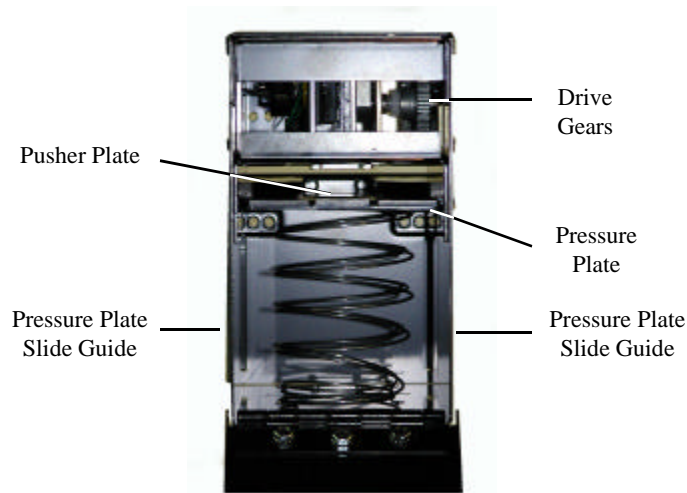

Figure 11. Universal SRC – Back View of Internal Parts

8. PERIODIC CLEANING

Depending on its environment and amount of use, the ARGUS Currency Validator may require periodic cleaning to restore the unit to optimum performance. Under normal use, the Currency Validator should be cleaned every 6 to 12 months. For unusual operating conditions, such as when the unit is exposed to dirt, dust, water spray, airborne oil, and/or sand, more frequent cleaning will be required.

8.1 Cleaning the Bezel

To remove dirty deposits and smudges from the bezel and other surfaces of the Currency Validator, use a soft, lint-free cloth, dampened with a **90-percent solution of isopropyl alcohol** only.



CAUTION: DO NOT flood the bezel area with alcohol, as this can damage the electronics integrated within the bezel.

8.2 Cleaning the Currency Channel

With constant use, a buildup of dirt, which is transferred from the surface of the bills, will accumulate on the pressure rollers, drive belt surfaces, magnetic head, and optics. Periodically, these items should be cleaned to ensure reliable operation.

8.2.1 Required Items

The following items are required to clean the Currency Validator:

- ◆ *Soft, lint-free cloth*
- ◆ *Isopropyl alcohol (90-percent solution).*

8.2.2 Procedure

To clean the currency channel, perform the following steps:



WARNINGS:

1. AVOID PERSONAL INJURY AND/OR SEVERE DAMAGE TO THE VALIDATOR. DISCONNECT POWER SUPPLY BEFORE CLEANING OR PERFORMING MAINTENANCE ON VALIDATOR.
2. REDUCE AND/OR PREVENT RISK OF ELECTRIC SHOCK. DO NOT CLEAN OR REPAIR THE VALIDATOR IN A DAMP OR WET ENVIRONMENT.
3. AVOID DANGEROUS SITUATIONS. DO NOT INTRODUCE FLAMMABLE LIQUIDS OR GASES TO MAINTENANCE WORK AREA WHEN CLEANING OR PERFORMING MAINTENANCE ON CURRENCY VALIDATOR.

Global Payment Technologies, Inc.

1. Power down the Currency Validator and disconnect the Main Connector Cable from the 22-pin Main Connector Shroud Socket on the Currency Validator.
2. Remove the Currency Validator from its mounting frame.



CAUTIONS:

1. DO NOT scratch the surfaces of the optics windows or the magnetic head while cleaning these devices, as this can impair the validator's performance.
 2. DO NOT allow liquid to enter the validator unit, as this can damage electrical components.
 3. DO NOT use unapproved cleaners; unapproved cleaners may cause permanent surface damage. Use only cleaners as directed in this procedure.
 4. DO NOT use cotton swabs to clean the unit as this can leave unwanted material on the surfaces.
3. Open the Currency Validator by releasing the spring-loaded latches and swinging out the Upper-Guide Assembly, exposing the currency channel with its optical system and magnetic head.
 4. Using a soft, lint-free cloth dampened with 90-percent isopropyl alcohol, clean the following areas (**Figure 12**):
 - a) Currency channel surfaces: remove any surface dirt on both the upper and lower guides.
 - b) Optics window area: clean all optic window surfaces (top and bottom).
 - c) Mag head: carefully remove any deposits from the surface area of the head; DO NOT scratch the surface area.
 - d) Pressure Rollers: clean all rollers on the Upper-Guide and Lower-Guide Assemblies.
 - e) Belt surfaces: clean all exposed belt surfaces.
 - f) Front and Rear Optical Sensors: clean all surfaces.
 - g) Side-looking sensors: clean all surfaces.
 5. Swing the Upper-Guide Assembly to its fully closed (locked) position, and verify that the spring-loaded latches are engaged.

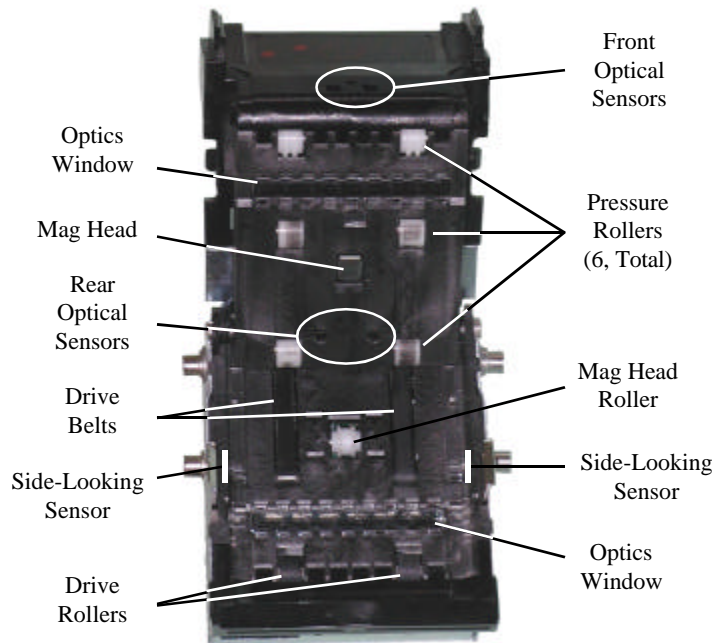

Figure 12. Currency Channel – Cleaning Surfaces

6. Mount the Currency Validator into the enclosure of the host machine.



WARNING: PERSONAL INJURY AND/OR DAMAGE TO EQUIPMENT MAY RESULT BY APPLYING INCORRECT VOLTAGE TO THE CURRENCY VALIDATOR. ONLY APPLY VOLTAGE AS SPECIFIED ON **CE/WARNING** LABEL (Figure 3).

7. Connect the Main Connector Cable to the 22-pin Main Connector Shroud Socket on the Currency Validator.
8. Apply power and close the door of the host machine.



Note: On the bezel, observe that each pair of green LEDs are flashing sequentially at 4 Hertz. If LEDs are not flashing or the red LED is lit, proceed to Troubleshooting (**Section 7**).

9. The Currency Validator is operational and ready to accept currency.

9. TESTING

The ARGUS Currency Validator should be tested when the unit is reconfigured to accept different size currency or when maintenance is required. Also, *GPT* recommends that the Currency Validator is tested prior to servicing or before it is shipped to *GPT* for repair. To test the Currency Validator, the service technician will perform the Video-Level Adjustment.

9.1 Video-Level Adjustment

The Video-Level Adjustment (VLA) is used to test and optimize the optics of the Currency Validator. Using a VLA Card, which is approved and provided by *GPT* only, the service technician can calibrate the optical sensing circuitry to its optimum levels.

The VLA should be performed at a temperature between 25 and 45 °C. This procedure must be done after the Currency Validator is disassembled and reassembled (e.g., when the width of the currency channel is changed).

 **Note:** The VLA is not required when a new data-base is loaded into the Currency Validator.

9.1.1 Required Items

- ◆ VLA Card for 70-mm wide channel (*GPT* PN 300E0005); or,
VLA Card for 85-mm wide channel (*GPT* PN 300E0019)
- ◆ Small DIP-switch manipulator (e.g., a small, non-metallic, non-conductive stick-like item such as a toothpick or plastic tweezers).

9.1.2 Procedure

To perform the VLA, proceed as follows:

1. Power down the Currency Validator.
2. Set DIP-Switches 8 and 9 to the **on** (down) position (**Figure 13**); set all remaining switches to the **off** (up) position.



Note: DIP-Switches 8 and 9 are used for servicing the Currency Validator. All other DIP-Switches are set as specified by the applicable Program Specification Sheet for your unit. Upon completion of this procedure, refer to the Program Specification Sheet to obtain the DIP-switch settings for your particular software configuration.

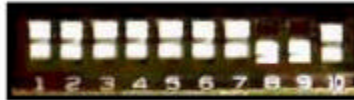

Figure 13. 10-Position DIP-Switch Package

3. Power up the Currency Validator.



CAUTION: DO NOT use cut, torn, creased, folded or perforated VLA cards for this test. Such damaged cards should be discarded.

4. Insert the VLA Card within 15 seconds after power is applied to the Currency Validator.
5. With the VLA Card fully inserted into the currency channel, observe the red, LED on the bezel is blinking; the blinking LED indicates the temperature range is being verified.
6. When the temperature reaches the desired range (between 25 and 45 °C) or after 5 minutes has elapsed, whichever occurs first, the LED will stop blinking and will remain lit; upon completion of VLA, the card will be ejected.



Note: The VLA card should be stored on a flat surface to prevent damage (e.g., creases and folds) to the card.

7. Power down the Currency Validator.
8. Set DIP-Switches 8 and 9 to the **off** position, and set all other switches as specified by the applicable Program Specification Sheet for your software configuration.

10. REQUESTING SERVICE

When calling for service, have the following information ready so that a *GPT* Customer Service associate can quickly assist you. Refer to the Company Directory (**Subsection 10.1**) for the nearest *GPT* Service Center in your area.

- ◆ Serial number (**Figure 3**)
- ◆ Part number (**Figures 3 and 4**)
- ◆ Program revision number (**Figures 3 and 5 or Figures 3 and 6**)
- ◆ Self-Diagnostic Error Displays (**Subsection 6.2**) or a description of the problem.

10.1 Company Directory

Global Payment Technologies, Inc.

General Information: **1-800-472-2506**

E-Mail Addresses:

Sales Information **sales@gptx.com**

Customer Service **customerservice@gptx.com**

Global Payment Technologies, Inc.

Corporate Headquarters

425-B Oser Avenue
Hauppauge, New York 11788-3640
USA
Tel : +(631) 231-1177 or 1-800-472-2506
Fax : +(631) 434-1771

GPT Las Vegas

(Regional Sales Office)
3068 East Sunset Road, Suite 3
Las Vegas, Nevada 89120-2785
USA
Tel : +(702) 597-9660
Fax : +(702) 597-9663

10.1 Company Directory (Continued)

Global Payment Technologies

Australia, (Pty.) Ltd.

844 Pacific Highway
Gordon, N.S.W. 2072
Australia
Tel : +(612) 9499-3100
Fax : +(612) 9499-3048

Global Payment Technologies, Ltd.

Europe

29 Park Royal Metro Centre
Britannia Way, London NW10 7PA
Tel : +(44) (208) 961-6116
Fax : +(44) (208) 961-6117

Global Payment Technologies Holdings (Pty.) Ltd.

South Africa

Unit 26, The Woodlands
Western Services Road, Woodmead
South Africa
Tel : +(27) (11) 804-5025
Fax : +(27) (11) 804-5026

Notes:

**GLOBAL PAYMENT TECHNOLOGIES, INC.
LIMITED WARRANTY PROVISION**

Global Payment Technologies, Inc. (*GPT*) extends the following limited warranty to the purchaser (Purchaser) of *GPT* products (Products). Unless otherwise authorized and agreed to in writing by *GPT*, all Products are guaranteed to be free of defects in material and workmanship for the period outlined in the Product Line Warranty table noted below. *GPT* agrees to repair or replace, without charge during the applicable warranty period, any unit which proves to be defective upon examination by *GPT* or its licensed affiliates, provided that such unit is accompanied by proof of purchase satisfactory to *GPT*. Any and all associated risks and costs of shipping, including, but not limited to, any applicable duties and tariffs, for an allegedly defective unit to or from the offices of *GPT* or its licensed affiliates shall be borne by the Purchaser.

This warranty applies only if all parts of the Products have been properly serviced according to the applicable product manual, and provided the alleged defective part, upon examination by *GPT* or its licensed affiliates, in their sole determination, shall prove to be defective. This warranty will not apply to any of the Products in which the electronic PCB assemblies, or any other part, has been subject to any modification, accident, abuse, or misuse. Determination of such modification, accident, abuse or misuse will be solely at the discretion of *GPT* or its licensed affiliates.

GPT grants Purchaser a limited, nonexclusive and nontransferable license to use the software provided with the Product (Software). *GPT* shall take commercially reasonable efforts to create Software databases that will not accept any type of fraudulent or counterfeit notes. Additionally, *GPT* shall, from time to time, update the Software to eliminate the acceptance of fraudulent or counterfeit notes (Updates). However, *GPT* cannot and does not warrant or accept any liability that such notes will not be accepted at any time while using the Product, Software and/or the Updates. The Updates shall come with the same license terms as the Software, and shall be offered to Purchaser at a cost to be determined by *GPT*. Both the Software and Updates are provided "AS IS" and *GPT* shall at all times retain title to the Software and Updates, including any and all copies, regardless of the form or media, and to all copyrights and intellectual property rights applicable therein.

THIS WARRANTY SHALL BE IN LIEU OF ANY OTHER WARRANTY, EXPRESS OR IMPLIED, INCLUDING BUT NOT LIMITED TO, ANY IMPLIED WARRANTIES OF MERCHANTABILITY, TITLE, NON-INFRINGEMENT AND FITNESS FOR A PARTICULAR PURPOSE. THERE ARE NO OTHER WARRANTIES, INCLUDING BUT NOT LIMITED TO, ANY IMPLIED WARRANTIES OF MERCHANTABILITY, TITLE, NON-INFRINGEMENT AND FITNESS FOR A PARTICULAR PURPOSE, WHICH EXTEND BEYOND WHAT IS DESCRIBED HEREIN UNLESS AUTHORIZED IN WRITING BY *GPT*. IF THIS PRODUCT DOES NOT PERFORM AS WARRANTED HEREIN, PURCHASER'S SOLE REMEDY SHALL BE REPAIR OR REPLACEMENT OF THE PRODUCT, AT *GPT*'S OPTION. IN NO EVENT WILL *GPT* BE LIABLE FOR ANY INDIRECT, SPECIAL, INCIDENTAL, EXEMPLARY OR CONSEQUENTIAL DAMAGES (INCLUDING, BUT NOT LIMITED TO, DAMAGES FOR LOST REVENUE, LOST WAGES, LOST SAVINGS OR LITIGATION) ARISING FROM THE PURCHASE, USE OR INABILITY TO USE THIS PRODUCT AND/OR THE SOFTWARE, EVEN IF *GPT* HAS BEEN ADVISED OF THE POSSIBILITY OF SUCH DAMAGES.

Product Line Warranty Table

Product Line	Warranty Period
Argus Validators	18 months parts and labor; 24 months parts from the date of shipment of goods from <i>GPT</i> 's factory.
Security Removable Cassettes (SRC)	One (1) year parts and labor from the date of shipment of goods from <i>GPT</i> 's factory.
Repaired Products (In-Warranty)	90 days or the remainder of the standard warranty period, whichever is longer. This period is from the date of shipment of goods from <i>GPT</i> 's factory.
Repaired Products (Out-of-Warranty)	90 days from the date of shipment of goods from <i>GPT</i> 's factory.

Global Payment Technologies, Inc.



Innovative Ideas . . . Global Acceptance